



Double Ridged Horn Antenna

Specification

Model : MDH00718



Frequency Range(GHz)	0.7 - 18.0
Gain(dB)	12 Typ.
Polarization	Linear
VSWR	2.0:1 Typ.
Impedance	50Ω
Connector	N-F or SMA-F
Size(mm)	244x160x230

Outline Drawing (mm)

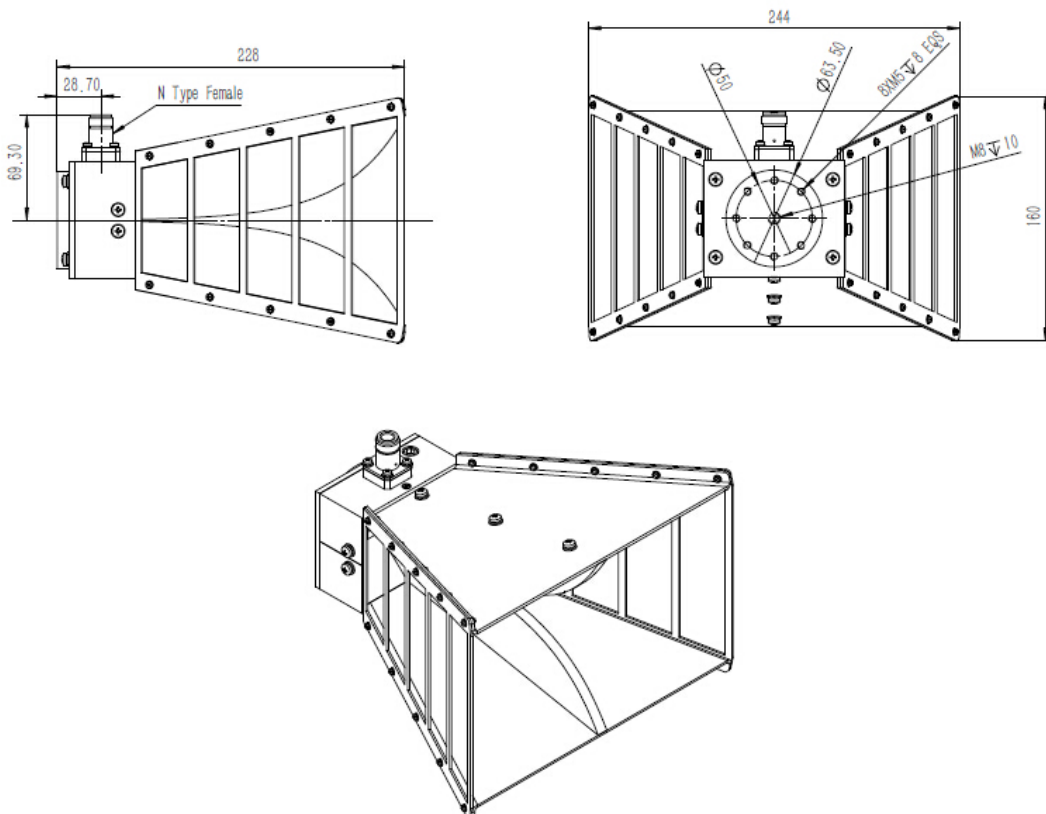

Antenna Gain (typ.)

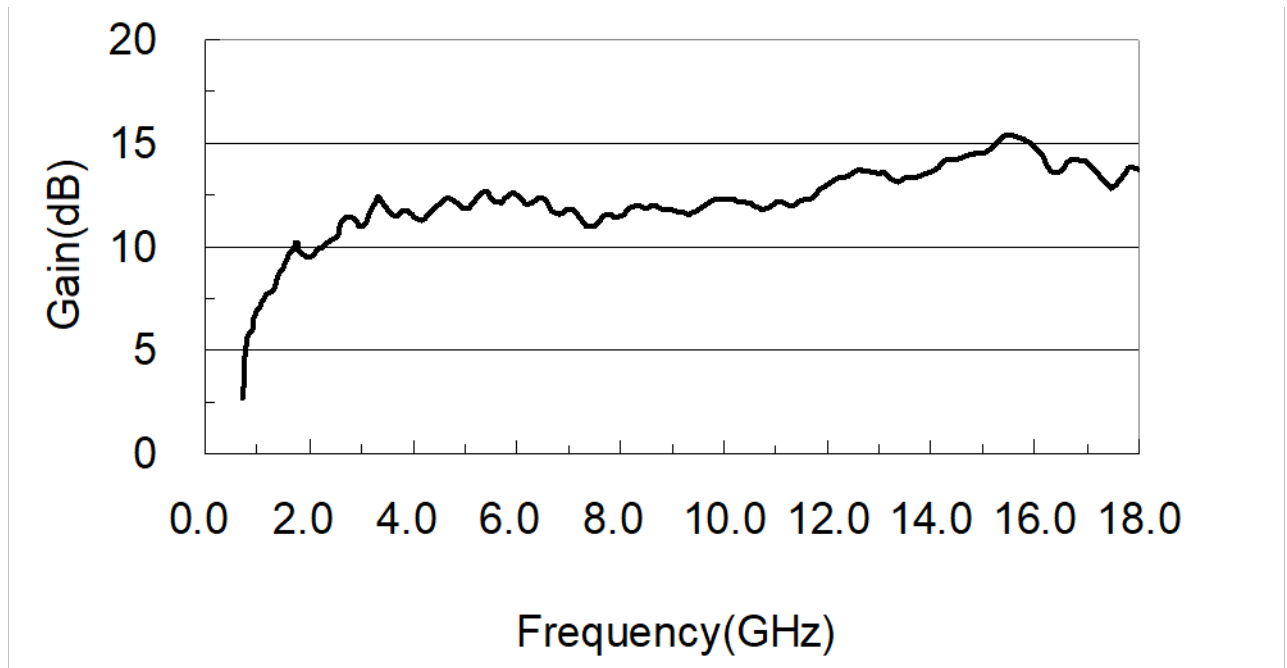

Radiation Patterns (typ.)

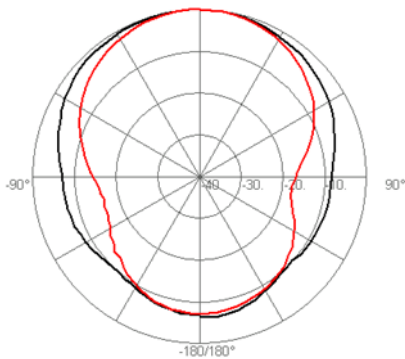

700 MHz

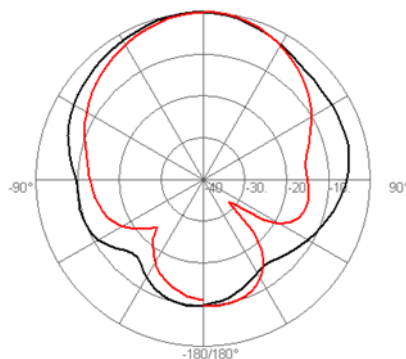

1GHz

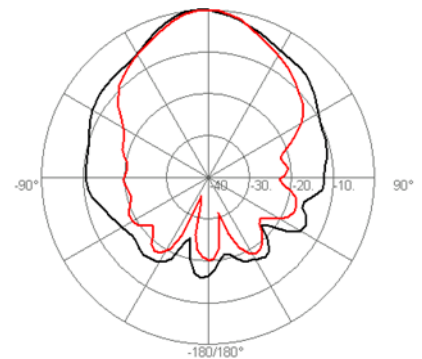

3GHz

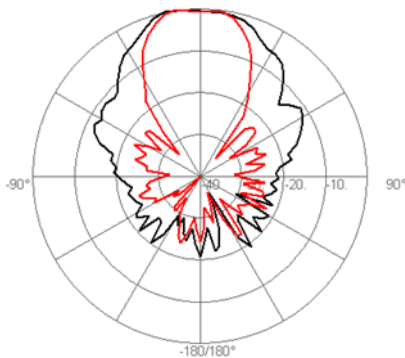

8 GHz

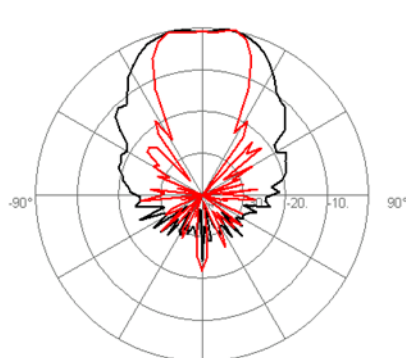

12GHz

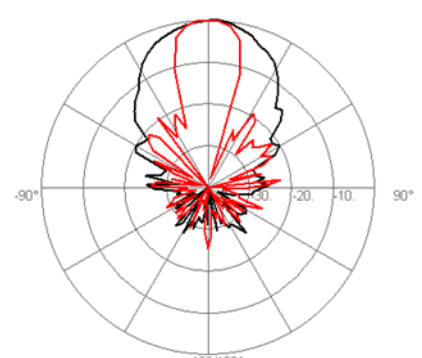

18GHz